

DES – 43

Heat Seal Machine



Texas Automation Products, Inc.

300 Nichols Drive

Hutchins, TX 75141

CONTENTS

About This Manual.....	2
Replacement Parts and Technical Assistance	2
Chapter 1: Introduction to the DES-43 Pneumatic Heat Seal Machine	3
Chapter 2: Installing the DES-43	5
Unpacking and Inspecting the DES-43	5
Locating and Securing the DES-43.....	5
Electrical and Compressed Air Requirements.....	5
Power Consumption.....	6
Connecting the Electrical Power Supply	6
Connecting Compressed Air	6
Setting or Adjusting the Air Line Pressure	7
Turning on Power to the DES-43.....	8
Chapter 3: General Operating Principles.....	9
General Heat Sealing Principles	9
Actuating the Heat Seal Machine.....	9
Using the Emergency Release Pushbutton	9
Chapter 4: Using the DES-43 Control Panel	10
Layout of the Control Panel	10
Start-up and Monitoring Mode.....	11
Chapter 5: Setting Cycle Dwell Time	14
Chapter 6: Setting Top Platen Temperature.....	15
Chapter 7: Setting Bottom Left Platen Temperature	16
Chapter 8: Setting Bottom Right Platen Temperature	17
Chapter 9: Setting Air Line Pressure (PSI) Lockout Range	18
Chapter 10: Cycle Count	19
Resetting Cycle Count	20
Chapter 11: Setting a Control Lockout Sequence.....	21

About This Manual

This manual contains information on how to install and program the DES-43 pneumatic heat seal machine. It provides an overview of the machine, an explanation of the control panel, and step-by-step instructions to operate the DES-43.

Replacement Parts and Technical Assistance

For replacement parts or technical assistance, please contact:

Texas Automation Products, Inc.
300 Nichols Drive
Hutchins, TX 75141
972-288-5000
800-872-1960
Fax 972-288-6022
info@texasautomationproducts.com

Please have your model and serial number when calling for service.

Warranty

This machine is fully warranted against defects in workmanship and material for 1 year from the date of purchase. Platen covers are excluded from warranty.

Chapter 1: Introduction to the DES-43 Pneumatic Heat Seal Machine

The DES-43 is the most advanced heat sealing machine in the industry. In addition to being dependable and easy to use, it offers the following features and capabilities:

- Power “ON-OFF” Switch.
- Intel Microprocessor based system controls and monitors all machine functions.
- User friendly illuminated pushbutton inputs for setting of machine functions. Large red LED display can be easily read up to 30 feet away and the readout has a rotating sequence to display the time, temperature, and pressure settings.
- Three conveniently located “Start Cycle” pushbuttons, one located on the front handle and one located on each side of the machine. (To initiate cycle, the start button on the handle must be depressed simultaneously with either one of the start buttons located on the sides.)
- Oversized “Emergency Release” pushbutton is located on each side of the machine. If either one is actuated, press will immediately open.
- Machine will cycle ONLY when top platen is in position directly over a bottom platen.
- Top head swivels smoothly on two frictionless sealed bearings that are permanently lubricated.
- Dual Cycle Timer is programmable in ½ second increments. After the machine is actuated, the timer counts down until the cycle is completed allowing the operator to monitor the status of cycle at any time.
- Built in resettable cycle counter displays cycle count up to 3999 and counts completed and in-completed cycles independently on both cycle times. This discourages the practice of operator short cycling, a major cause of tape adhesion failure.
- Top and bottom platen temperatures are adjustable from 100° to 450° Fahrenheit. Top or bottom platen temperature can be turned “OFF” individually if desired.
- Air Regulator / Filter / Gauge Assembly attached to machine.
- Air Pressure adjustable from 25 to 120 psi. Total platen pressure is approximately 707 lbs. at 100 psi line pressure.
- The Air Cylinder has a ¾” diameter piston rod and the Guide Bar is made of ½” diameter steel and glides through a DU bearing. Both assure long life, rigidity, and platen alignment.
- Control Lockout feature prevents unauthorized personnel from tampering with machine settings.
- Parameter Lockout feature prevents operator from cycling machine if temperature or pressure varies more than +/- 10 from their set point.
- Slide on Platen Covers for quick change from sponge pad or teflon surface.
- Electrical Fuse mounted on circuit board inside machine.

- Rigidly built for minimal press “breathing”.
- Spacious throat area allows for easy handling of large or bulky items.
- Many self-diagnostic features are incorporated into the machine control system to help locate malfunctions if they should occur.
- Easy to maintain and operate.

Industrial laundries, uniform rental plants, garment manufacturers, hospitals, nursing homes, and sportswear manufacturers use the DES-43 to apply the following types of heat seal materials:

- Label tapes
- Emblems
- Appliques
- Ink transfers
- Patches
- Embroideries
- Barcode labels
- Flock appliques
- Mending tapes
- Interfaces
- Pressure-sensitive materials
- Heat-sensitive materials

Chapter 2: Installing the DES-43

This chapter provides instructions to help you unpack the DES-43, check that you have all the components, and make the hardware connections. Perform the installation procedures in the order in which this chapter presents them.

Unpacking and Inspecting the DES-43

To remove the DES-43 from the shipping crate, you need the following tools:

- A knife or suitable sharp instrument
- A ½" socket wrench or suitable tool

Cut the cardboard box where it joins the skid. With the socket wrench or other suitable tool, remove the three bolts that secure the DES-43 to the skid. Carefully lift the DES-43 from the skid and remove all other materials from the shipping crate.

You should have all of the following items:

- The DES-43 pneumatic heat seal machine
- The package in which you found this operations manual

Locating and Securing the DES-43

Before connecting power and air, locate the DES-43 heat seal machine where it will be operated. Choose a location that provides the electrical and compressed air requirements. Bolt base of machine securely in desired place and position.

Electrical and Compressed Air Requirements

- 120 volt, 60 Hertz power supply
- Air – 25 PSI minimum / 120 PSI maximum, .025 Cu. Ft. free air per cycle

Power Consumption

PLATEN SIZE	WATTS	AMPS
2" x 4"	900	7.5
3" x 5"	1200	10
4" x 6"	1320	11
5" x 6"	1800	15
3 ¼" x 5" Extended Anvil	660	5.5

Connecting the Electrical Power Supply

Before connecting electrical power to the DES-43, push the DES-43's toggle power switch down to the "OFF" position. Plug the DES-43's power cord into an appropriate power source, such as a standard receptacle. The electrical power cord has a molded 15 amp plug.

Connecting Compressed Air

To connect the air supply to the DES-43, perform the following:

- Remove the 1/8" male NPT pipe plug from the air line connector located in the back at the base of the machine. This plug will protect against contaminants entering the air system.
- After removing the plug, connect the air supply to the 1/8" female NPT air line connector.

Setting or Adjusting the Air Line Pressure

To set or adjust the air line pressure, locate the Air Regulator on the right side of the swivel head. The required gauge pressure must be in the range of 25 PSI minimum / 120 PSI maximum. To adjust the regulator, pull up and turn black knob. Clockwise increases pressure; counter-clockwise decreases pressure. When pressure is set, push down black knob to lock. The following table converts gauge pressure to total inter-platen pressure and pounds of pressure per square inch on platen surface.

CONVERSION TABLE						
GAUGE PRESSURE	TOTAL INTER-PLATEN PRESSURE	LBS. PSI 2" x 4" PLATEN	LBS. PSI 3" x 5" PLATEN	LBS. PSI 4" x 6" PLATEN	LBS. PSI 5" x 6" PLATEN	LBS. PSI 3 1/4" x 5" EXTENDED ANVIL PLATEN
25	177	22.1	11.8	7.4	5.9	10.9
30	212	26.5	14.1	8.8	7.1	13.0
35	247	30.9	16.5	10.3	8.2	15.2
40	283	35.4	18.9	11.8	9.4	17.4
45	318	39.8	21.2	13.2	10.6	19.6
50	353	44.1	23.5	14.7	11.8	21.7
55	389	48.6	25.9	16.2	13.0	23.9
60	424	53.0	28.3	17.7	14.1	26.1
65	459	57.4	30.6	19.1	15.3	28.2
70	495	61.9	33.0	20.6	16.5	30.5
75	530	66.2	35.3	22.1	17.7	32.6
80	565	70.6	37.7	23.5	18.8	34.8
85	601	75.1	40.1	25.0	20.0	37.0
90	636	79.5	42.4	26.5	21.2	39.1
95	672	84.0	44.8	28.0	22.4	41.4
100	707	88.4	47.1	29.5	23.6	43.5
105	742	92.7	49.5	30.9	24.7	45.7
110	778	97.2	51.9	32.4	25.9	47.9
115	813	101.6	54.2	33.9	27.1	50.0
120	848	106.0	56.5	35.3	28.3	52.2

Turning on Power to the DES-43

Before turning on power, read the rest of this chapter carefully to learn how to make the necessary adjustments and avoid potential problems. We recommend that you read this entire manual to become familiar with its contents before operating the DES-43.

To turn on the DES-43, perform the following:

- Push the toggle power switch up to the “ON” position.

Wait about two seconds for the DES-43 to adjust. After the unit’s circuits settle, the control panel displays the version of central processing unit (CPU) software and enters Monitoring mode. For a complete explanation of Monitoring mode and the controls, see Chapter 4, *Using the DES-43 Control Panel*.

Caution: If you press the Control Lockout button while the control panel is in Monitoring mode, it will enter Set Lockout mode. In Set Lockout mode, you can select a three-button sequence as a code to prevent unauthorized personnel from changing the parameters. Immediately press Control Lockout again to exit this mode. See Chapter 11, *Setting a Control Lockout Code*, for more information.

Chapter 3: General Operating Principles

Before you start using the DES-43 pneumatic heat seal machine, read this chapter to become familiar with general principles of all heat sealing operations and to learn the following operating procedures that are specific to the DES-43.

- Actuating the DES-43
- Using the Emergency Release pushbutton

General Heat Sealing Principles

All heat sealing processes involve three main factors, as follows:

- The temperature of the platens;
- The inter-platen pressure;
- The cycle dwell time.

To set tolerances and control values for platen temperature, inter-platen pressure, and cycle dwell time, use the DES-43 control panel. For more information, see Chapter 4, *Using the DES-43 Control Panel*. You can also use the control panel's digital display area to monitor the actual platen temperatures and air line pressure. The exact settings of the three main factors depend on the requirements of your specific fusing or transfer application.

Actuating the Heat Seal Machine

To actuate the DES-43:

- Position top platen over one of the bottom platens and depress the black pushbutton labeled "Start Cycle" located on the handle simultaneously with one of the black pushbuttons labeled "Start Cycle" located on either side of the swivel head. Machine will cycle ONLY when the top platen is in position directly over a bottom platen.

Using the Emergency Release Pushbutton

To interrupt the DES-43 during operation:

- Push one of the red "Emergency Release" pushbuttons located on either side of the swivel head. This safety feature bypasses the timer and immediately opens the press in case of an emergency. Only one red pushbutton need be depressed to interrupt cycle. Also, the press should open immediately if the power switch is turned "OFF", or if the machine power cord is unplugged.

Chapter 4: Using the DES-43 Control Panel

This section of this manual provides an overview of the control panel for the DES-43 pneumatic heat seal machine. Before you operate your machine, read this section to learn general information on using the control panel.

With the control panel, you can set tolerances and control values for platen temperature, inter-platen pressure, and cycle dwell time. You can also use the control panel's digital display area to monitor the DES-43's actual platen temperatures and air line pressure. The exact settings of the three main factors depend on the requirements of your specific fusing or transfer application.

Use the Top Temp, Bottom Left Temp and Bottom Right Temp buttons on the control panel to view and set the platens' temperatures. Use the Air Line PSI button to view the actual pressure of the heat seal machine's pressure regulator and to set a control range. Use the Cycle Time button in conjunction with either Cycle Time A or Cycle Time B button to set the actuation time and to view the current time setting.

Layout of the Control Panel

Figure 4-1 shows the DES-43 control panel with all nine control buttons off.

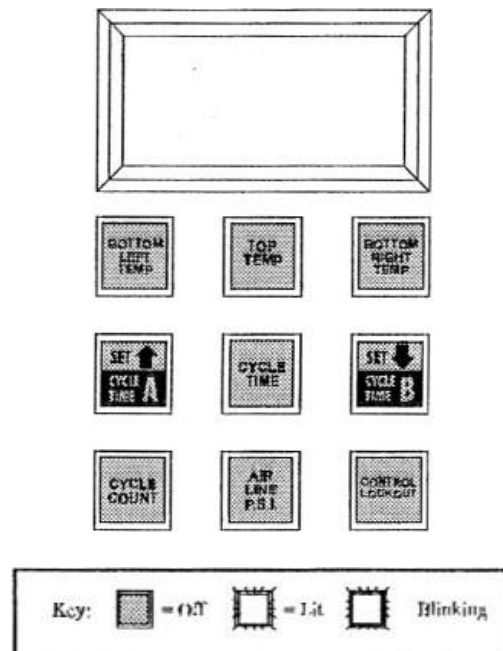

Figure 4-1
DES-43 Control Panel with Buttons Off

Start-up and Monitoring Mode

When you first turn on the DES-43, wait about two seconds for it to adjust. After the circuits settle, the control panel displays the version of CPU software and enters Monitoring mode. In Monitoring mode, the panel's numeric display area shows the following values:

- The cycle dwell time setting for cycle time A
- The current top platen temperature in degrees Fahrenheit
- The current bottom left platen temperature in degrees Fahrenheit
- The current bottom right platen temperature in degrees Fahrenheit
- The current air line pressure

The DES-43's control panel enters Monitoring mode on initial start-up and when the machine is idle. While in Monitoring mode, the control panel displays the current cycle dwell time setting for cycle time A, current top platen temperature, current bottom left platen temperature, current bottom right platen temperature, and current air line pressure, as shown in Figure 4-2. Because the control panel displays the platens' actual temperatures, it shows room temperature for them when they are not on. If the machine's pressure regulator is off, the control panel displays zero (0) for air line pressure.

While the control panel is in Monitoring mode, you can immediately see any function displayed by pressing and releasing either the Cycle Time A, Cycle Time B, Top Temp, Bottom Left Temp, Bottom Right Temp, Air Line PSI, or Cycle Count button.

Caution: If you press the Control Lockout button while the control panel is in Monitoring mode, it will enter Set Lockout mode. In Set Lockout mode, you can select a three-button sequence as a code that prevents unauthorized personnel from changing the parameters. Press Control Lockout again to exit this mode. See Chapter 11, *Setting a Control Lockout Sequence*, for more information.

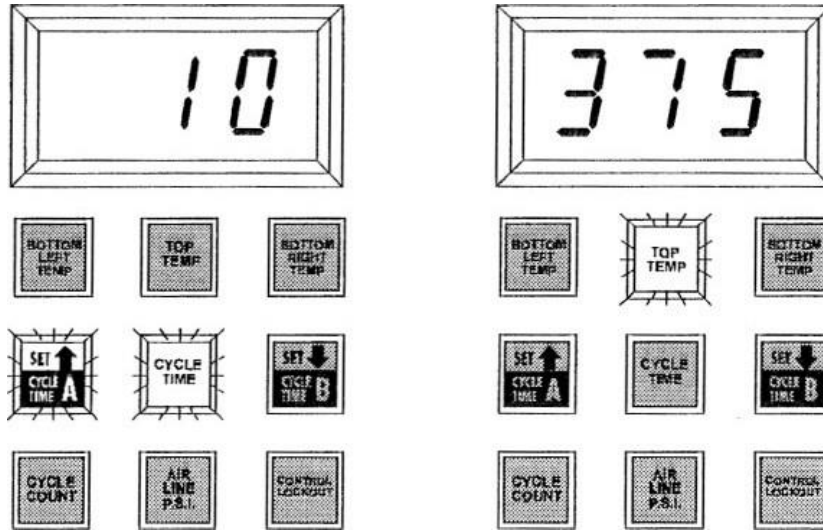

Cycle Time Setting

Current Top Platen Temperature

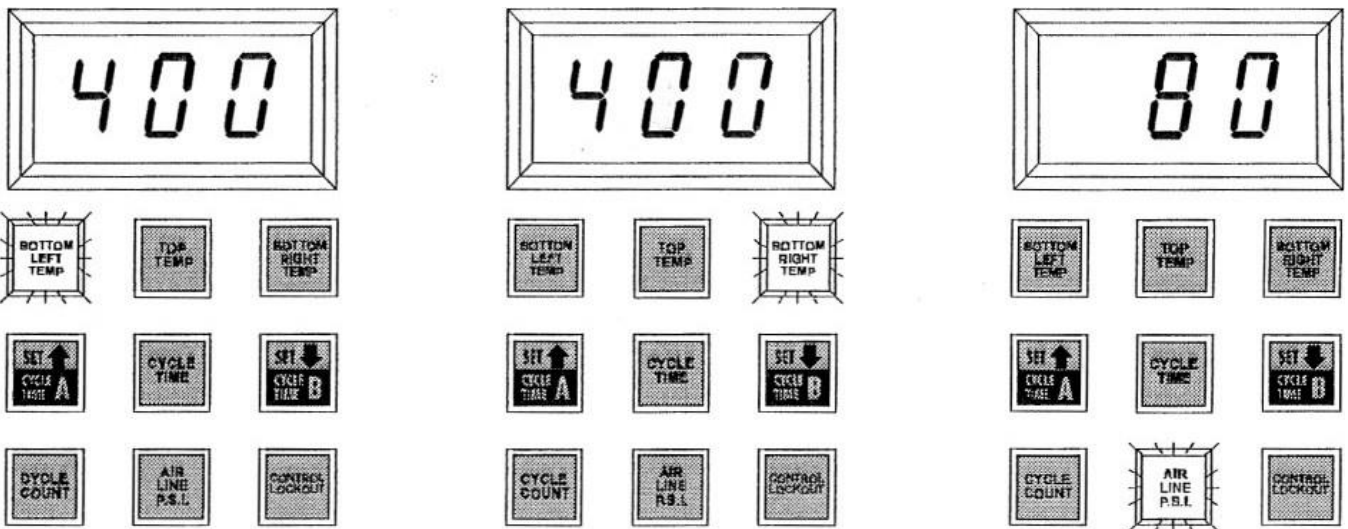

Current Bottom Left Platen Temperature

Current Bottom Right Platen Temperature

Current Air Line Pressure

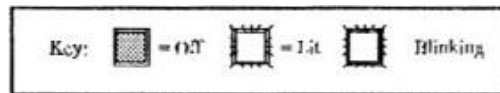
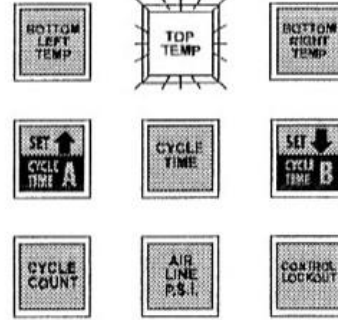
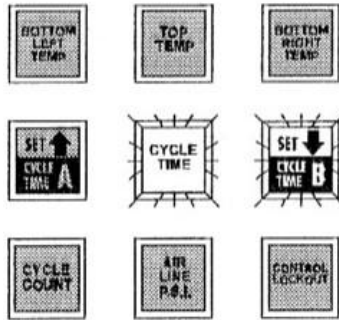
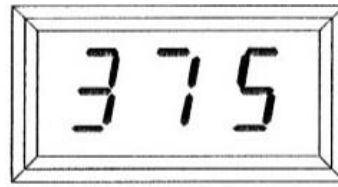
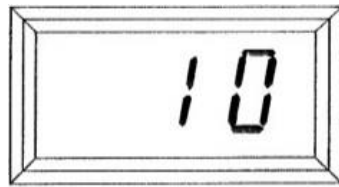
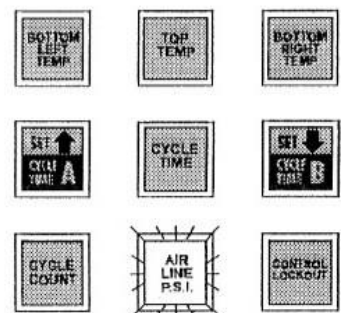
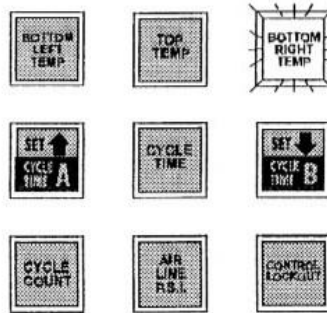
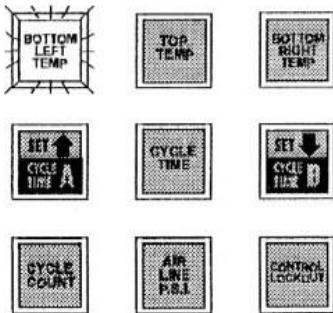

Figure 4-2
Monitoring Mode (Cycle Time A)



Cycle Time Setting

Current Top Platen Temperature



Current Bottom Left Platen Temperature

Current Bottom Right Platen Temperature

Current Air Line Pressure

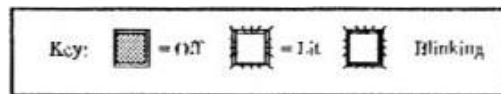

Figure 4-3
Monitoring Mode (Cycle Time B)

Chapter 5: Setting Cycle Dwell Time

This machine is equipped with a dual timer. After both cycle times are set, the operator can change the cycle time by pressing either the Cycle Time A or Cycle Time B button. To set the cycle dwell time, perform the following:

- While the control panel is in Monitoring Mode, press and release either Cycle Time A or Cycle Time B buttons to select the cycle time that you want to set. After selecting either Cycle Time A or Cycle Time B, press and hold the Cycle Time button. After approximately two seconds, the panel's Up Arrow and Down Arrow buttons will light and the Cycle Time button blinks, as shown in Figure 5-1. This puts the control panel in the Set Mode. Release the Cycle Time button. The control panel will display the current setting for the cycle dwell time.

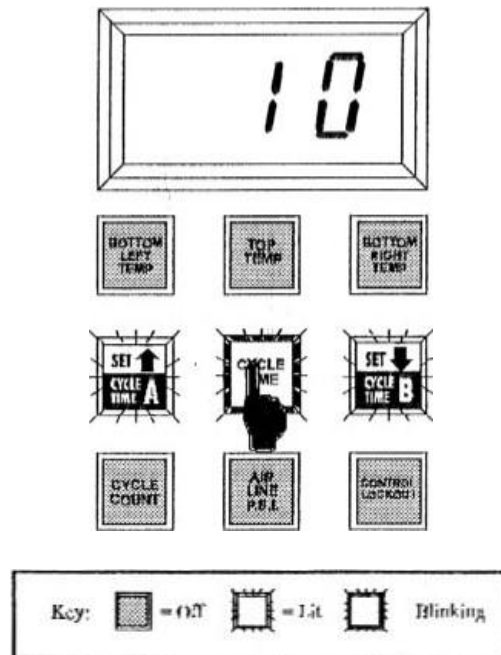



Figure 5-1
Setting Cycle Time

- Press either the Up Arrow or the Down Arrow button to change the setting; press and release to increase or decrease the setting by one increment. To rapidly change the value, press and hold the appropriate arrow button. Possible cycle dwell time values range from .5 seconds to 99.5 seconds (in .5 second increments) and from 100 to 999 seconds (in 1 second increments).
- After you reach the number of seconds that you want to set as the cycle dwell time, press and release the Cycle Time button again to save the setting and to return the control panel to Monitoring Mode.

Chapter 6: Setting Top Platen Temperature

To set the temperature of the top platen, perform the following:

- While the control panel is in Monitoring Mode, press and hold the Top Temp button. After approximately two seconds, the panel's Up Arrow and Down Arrow buttons will light and the Top Temp button blinks, as show in Figure 6-1. This puts the control panel in the Set Mode. Release the Top Temp button. The control panel displays the current setting for the top platen temperature (not the actual temperature, as shown in Monitoring Mode); if the platen is set to off, the control panel displays three dashes. 

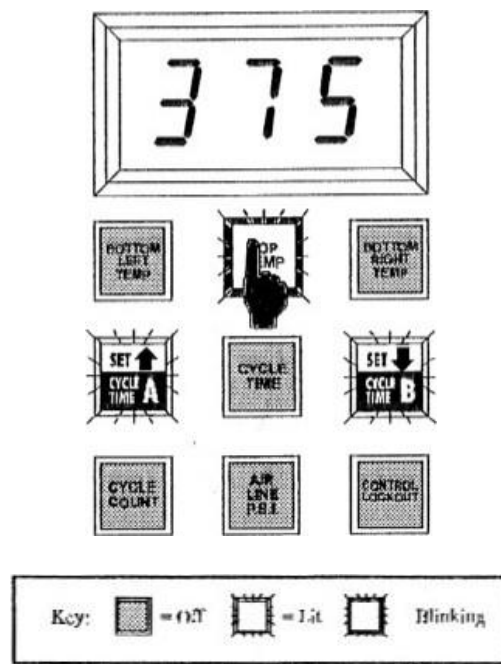



Figure 6-1
Setting Top Platen Temperature

- Press either the Up Arrow or the Down Arrow button to change the setting; press and release to increase or decrease the setting by one (1). To rapidly change the value, press and hold the appropriate arrow button. Possible top platen temperature values range from 100° to 450° Fahrenheit. To turn off the top platen, set the value as three dashes,  one above 450° and one below 100°.
- After you reach the temperature that you want to set for the top platen, press and release the Top Temp button again to save the setting and to return the control panel to Monitoring Mode.

Chapter 7: Setting Bottom Left Platen Temperature

To set the temperature of the bottom left platen, perform the following:

- While the control panel is in Monitoring Mode, press and hold the Bottom Left Temp button. After approximately two seconds, the panel's Up Arrow and Down Arrow buttons will light and the Bottom Left Temp button blinks, as shown in Figure 7-1. This puts the control panel in the Set Mode. Release the Bottom Left Temp button. The control panel displays the current setting for the bottom left platen temperature (not the actual temperature, as shown in Monitoring Mode); if the platen is set to off, the control panel displays three dashes. 

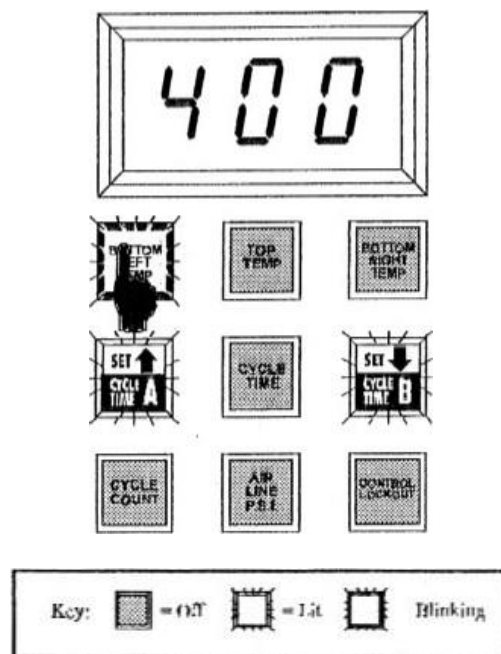



Figure 7-1
Setting Bottom Left Platen Temperature

- Press either the Up Arrow or the Down Arrow button to change the setting; press and release to increase or decrease the setting by one (1). To rapidly change the value, press and hold the appropriate arrow button. Possible bottom left platen temperature values range from 100° to 450° Fahrenheit. To turn off the bottom left platen, set the value as three dashes,  one above 450° and one below 100°.
- After you reach the temperature that you want to set for the bottom left platen, press and release the Bottom Left Temp button again to save the setting and to return the control panel to Monitoring Mode.

Chapter 8: Setting Bottom Right Platen Temperature

To set the temperature of the bottom right platen, perform the following:

- While the control panel is in Monitoring Mode, press and hold the Bottom Right Temp button. After approximately two seconds, the panel's Up Arrow and Down Arrow buttons will light and the Bottom Right Temp button blinks, as shown in Figure 8-1. This puts the control panel in the Set Mode. Release the Bottom Right Temp button. The control panel displays the current setting for the bottom right platen temperature (not the actual temperature, as shown in Monitoring Mode); if the platen is set to off, the control panel displays three dashes. 

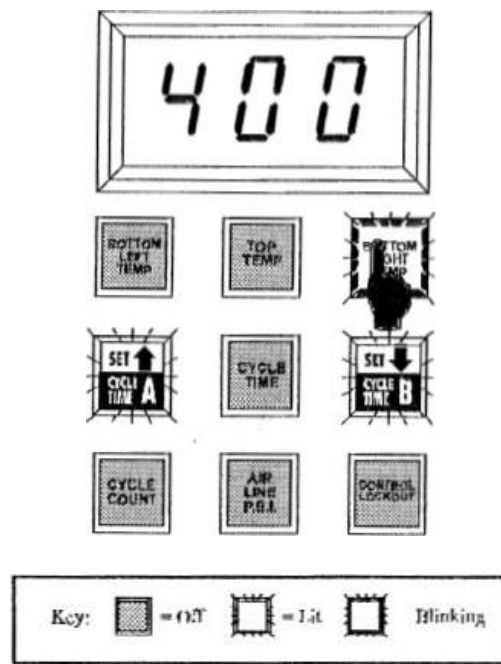



Figure 8-1
Setting Bottom Right Platen Temperature

- Press either the Up Arrow or the Down Arrow button to change the setting; press and release to increase or decrease the setting by one (1). To rapidly change the value, press and hold the appropriate arrow button. Possible bottom right platen temperature values range from 100° to 450° Fahrenheit. To turn off the bottom right platen, set the value as three dashes,  one above 450° and one below 100°.
- After you reach the temperature that you want to set for the bottom right platen, press and release the Bottom Right Temp button again to save the setting and to return the control panel to Monitoring Mode.

Chapter 9: Setting Air Line Pressure (PSI) Lockout Range

You cannot use the control panel to set the heat press device's actual air line pressure (see Chapter 2: *Setting or Adjusting the Air Line Pressure*). You must adjust the pressure regulator to the desired setting. However, you can use the control panel to set a range limit that prevents the heat seal machine from actuating unless the actual air line pressure is at the set value (within the tolerance range of either +/- 10 psi). This is preset at Texas Automation Products during manufacturing. To set the air line pressure lockout value, perform the following:

- While the control panel is in Monitoring Mode, press and hold the Air Line PSI button. After approximately two seconds, the panel's Up Arrow and Down Arrow buttons will light and the Air Line PSI button blinks, as shown in Figure 9-1. This puts the control panel in the Set Mode. Release the Air Line PSI button. The control panel displays the current pressure lockout setting.

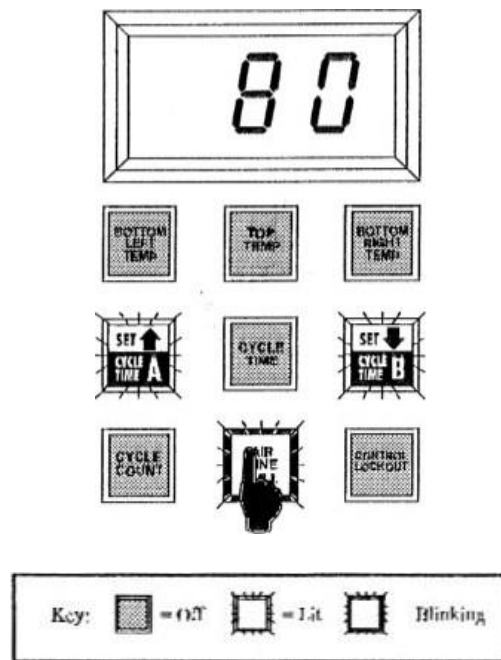

Figure 9-1
Setting Air Line Pressure Lockout

- Press either the Up Arrow or the Down Arrow to change the setting; press and release to increase or decrease the setting by one (1). To rapidly change the value, press the appropriate arrow key and hold it down. Possible pressure lockout values range from 25 psi to 120 psi.
- After you reach the pressure lockout value that you want, press and release the Air Line PSI button again to save the setting and to return to the control panel Monitoring Mode.



Chapter 10: Cycle Count

The control panel's cycle count feature allows you to accurately track the number of times the DES-43 has been actuated for the full-cycle dwell time and "short" cycle time on both the cycle A time and the cycle B time since the cycle count was last reset. Each time you actuate the heat seal machine for a completed cycle time setting, the control panel adds one (1) to its current cycle count. If the machine is actuated and it is "short" cycled, it will add one (1) to its current "short" cycle count. The control panel's display area can display numbers from 0 to 999, but it also uses decimal points, as shown in Table 10-1, to indicate cycle count values of 0 to 3999.



VALUE SHOWN ON CONTROL PANEL	ACTUAL CYCLE COUNT
000 to 999	000 to 999
000. to 999.	1000 to 1999
00.0. to 99.9.	2000 to 2999
0.0.0. to 9.9.9.	3000 to 3999

Table 10-1
Cycle Count Values

To view cycle count and "short" cycle count on cycle time A:

1. Press and release the Cycle Time A button.
2. Press and release the Cycle Count button to view the current full cycle count.
3. To view the current short cycle count, press and hold the cycle count button. After approximately 2 seconds the  button will light. Press and release the  button to view the short cycles.

To view cycle count and "short" cycle count on cycle time B:

1. Press and release the Cycle Time B button.
2. Press and release the Cycle Count button to view the current full cycle count.
3. To view the current short cycle count, press and hold the cycle count button. After approximately 2 seconds the  button will light. Press and release the  button to view the short cycles.

You cannot use the control panel to increase the cycle count value; the count only increases when the heat seal machine is successfully actuated for the full duration of the cycle dwell time. You can, however, lower the count by increments of one (to reflect uses that were not successful for reasons other than insufficient time) or reset the count completely to zero (0); for assistance, see the procedures in *Resetting Cycle Count* on the next page.

Resetting Cycle Count

To reset the heat seal machine's cycle time A count, perform the following while the control panel is in Monitoring Mode:

1. Press and release the Cycle Time A button.
2. Press and hold the Cycle Count button. After approximately two seconds, the panel's

 button will light and the Cycle Count button blinks, as shown Figure 11-1. This puts the control panel in Set Mode. Release the Cycle Time button. The control panel displays the current cycle count.

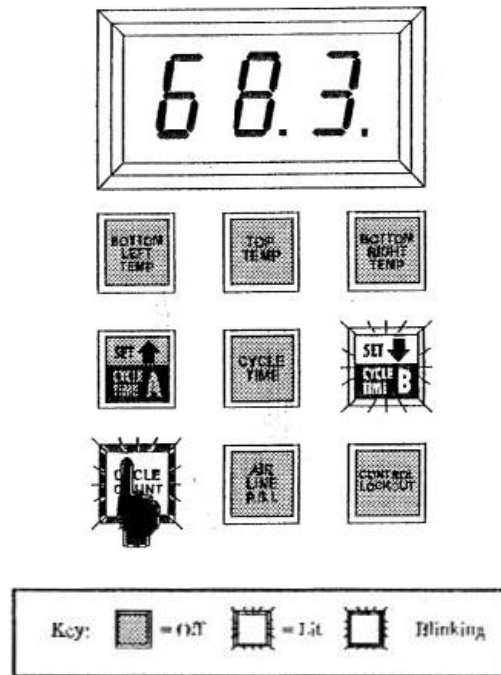





Figure 10-1
Resetting the Cycle Count

3. Press and release the  button to decrease the completed cycle setting by one (1).

To reset the value immediately to zero (0), press the  button and hold it down.

4. Press and hold the  button to reset the "short" cycle count to zero (0).
5. After you reach the cycle count that you want, press and release the Cycle Count button again to save the setting and return the control panel to Monitoring Mode.

Chapter 11: Setting a Control Lockout Sequence

To set a control lockout code to prevent unauthorized personnel from changing control panel settings, perform the following:

- Press and release the Control Lockout button. The Control Lockout button blinks. The control panel display will be blank, indicating that there is no code in effect.
- To set a control lockout code, you will enter a sequence of three buttons. Press and release any button (except for the Control Lockout button) as the first in a sequence of three entries.
- Repeat the step above for your remaining two code entries. (You may select three different buttons for your code or you may elect to use any of the buttons more than once.)
- After entering the last code the machine will automatically go into Monitoring Mode.

To enter your control lockout code, perform the following:

- Press and release the Control Lockout button. The Control Lockout button blinks and the control panel displays three dashes. Each dash represents one of the buttons comprising your code.
- Press and release the first button of your code sequence. If you have correctly entered the first button in your code, one dash displayed in the control panel disappears.
- Repeat the step above for each of the remaining two buttons in your code sequence. The remaining dashes displayed in the control panel will disappear as you press and release the correct buttons in sequence.
- After entering the last code the machine will automatically go into Monitoring Mode.

You must enter the code in the proper sequence. If you have entered the code correctly, the DES-43 automatically exits Set Mode. If you have not entered the code correctly, you may try again. However, you will be locked out after three unsuccessful attempts. The Control Lockout button will blink and the control panel display will indicate three blinking dashes. If this should happen, please call Texas Automation Products, Inc. for technical assistance at **800-872-1960**.

MODEL DES-40 and MODEL DES-42 FACEPLATE SCHEMATIC

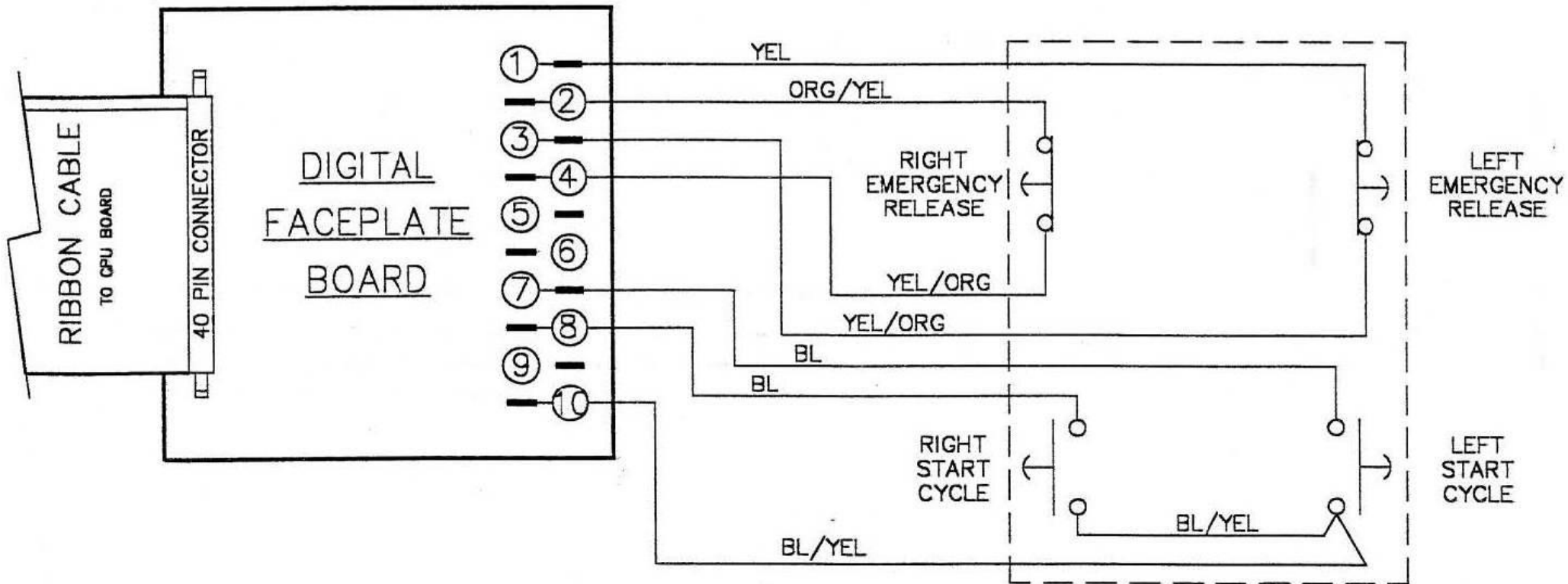

MODEL DES-40 and MODEL DES-42 (with 5"x6" PLATENS) MACHINE BASE SCHEMATIC

